



# The mesencephalic trigeminal sensory nucleus is involved in the control of feeding and exploratory behavior in mice

著者(英)	Ishii Toshiaki, Furuoka Hidefumi, Ito Takuya, Kitamura Nobuo, Nishimura Masakazu
journal or publication title	Brain Research
volume	1048
number	1-2
page range	80-86
year	2005-01-28
URL	<a href="http://id.nii.ac.jp/1588/00000335/">http://id.nii.ac.jp/1588/00000335/</a>

**The mesencephalic trigeminal sensory nucleus is involved in the control of feeding and exploratory behavior in mice**

Toshiaki Ishii<sup>1\*</sup>, Hidefumi Furuoka<sup>1</sup>, Takuya Itou<sup>1</sup>, Nobuo Kitamura<sup>2</sup>,  
and Masakazu Nishimura<sup>1</sup>

Department of <sup>1</sup>Pathobiological Science and <sup>2</sup>Basic Veterinary Science,  
Obihiro University of Agriculture and Veterinary Medicine,  
Obihiro Hokkaido 080-8555, Japan

The number of text pages: 18

The number of figures: 4

**Acknowledgements** This work was supported in part by a Grant-in-Aid for Scientific Research (B)(to T.I.) from Japan Society for the Promotion of Science, in part by The President Discretionary Budget of Obihiro University of Agriculture and Veterinary Medicine (to T.I.), in part by The Naito Foundation (to T.I.), and in part by a Grant-in-aid for COE from the Ministry of Education, Culture, Sports, Science, and Technology of Japan (E-1)(to T.I.).

\*Correspondence (to):

Dr. Toshiaki Ishii  
Department of Pathobiological Science,  
Obihiro University of Agriculture and Veterinary Medicine,  
Obihiro Hokkaido 080-8555, Japan  
(Phone) +81-155-49-5366, (Fax) +81-155-49-5369,  
(E-mail) [ishii@obihiro.ac.jp](mailto:ishii@obihiro.ac.jp)

## ***Abstract***

The mesencephalic trigeminal nucleus (Me5), which receives input from oral proprioceptors and projects to higher brain regions, is involved in mastication-induced modulation of satiation. To investigate how the Me5 is involved in the control of feeding and exploratory behavior, we examined the effect of bilateral electrolytic lesions of the Me5 on feeding and exploratory behavior in mice. Mouse feeding and exploratory behaviors were analyzed using a food-search-compulsion-apparatus (FSCA), which was designed to distinguish between the two behaviors under standard living conditions. To assess anxiety in mice in an unfamiliar environment, exploratory activity was analyzed in an automated hole-board apparatus. Mice with bilateral Me5 lesions had unique feeding and exploratory behavior profiles in the FSCA compared with sham-operated mice. Me5-lesioned mice spent more time in the food chamber during each trial in the FSCA, but the number of entries into the food chamber was decreased by 40% compared to sham-operated mice. Moreover, Me5 lesions markedly inhibited exploratory behavior, manifested as low-frequency exploration. In spite of the low-frequency exploration in the FSCA, Me5 lesions had no effect on various exploratory activities analyzed in the hole-board apparatus, i.e., total locomotor activity, frequency and duration of rearing and head-dipping, and latency to the first head-dipping. These results suggest that the Me5 is involved in the control of feeding and exploratory behavior through its ascending neuronal pathways in mice without modulating the emotional state.

**Theme:** Neural Basis of Behavior

**Topic:** Neuroethology

**Keywords:** feeding, exploratory behavior, Me5 lesions

## ***Introduction***

The mesencephalic trigeminal nucleus (Me5) receives proprioceptive sensory afferents of the trigeminal nerve from the jaw-closing muscle spindles and the periodontal ligaments, and also innervates the motor trigeminal nucleus, relating to the jaw-jerk reflex [2,7]. The Me5 fibers also project into the tuberomammillary nucleus (TMN) of the posterior hypothalamus where the cell bodies of histamine (HA) neurons are localized [3]. HA neurons in the TMN project to the ventromedial hypothalamus (VMH) and to the Me5 [8,9,14]. Fujise et al. (1993) [5] suggested that the oral proprioceptive signals induced by mastication might modulate hypothalamic HA neurons through the ascending pathway from the Me5. In fact, the HA nerve systems in the VMH and Me5 are activated in response to feeding, although the time necessary for activation of both regions differs [6].

Fujise et al. (1998) [6] demonstrated that the Me5 is involved in mastication-induced modulation of satiation and eating parameters. Their study suggests that the Me5 receives signals relating to mastication-induced proprioceptive sensation and modulates satiation via a satiety center in the VMH. Their role of the Me5 in feeding and related behaviors, however, remains unknown. In the present study, to investigate how the Me5 is involved in the control of feeding and exploratory behavior, we examined the effect of bilateral electrolytic lesions of the Me5 on feeding and exploratory behavior in mice using a food-search-compulsion-apparatus (FSCA), which was designed to distinguish between feeding and exploratory behaviors under standard living conditions. Moreover, we analyzed various exploratory activities using an automated hole-board apparatus to evaluate whether Me5 lesions affect the emotional state and spontaneous activity of mice.

## **Methods**

### **Animals and FSCA**

Male *ddy* mice were maintained under controlled temperature and lighting conditions with a 12-h light/dark cycle (lights on at 0600). Feeding and exploratory behavior were monitored using an FSCA (Fig. 1A). The FSCA was an acrylic cage equipped with two separate vertical cylinders (180 cm high) of stainless steel wire, the tops of which had a chamber containing either food or nothing. Mice had to climb up to the chamber to seek and obtain food. The number of entries and the duration of time spent in each chamber were monitored using detectors attached to the chambers. Mice could obtain water *ad libitum* without climbing the cylinders.

### **Me5 lesions**

Bilateral electrolytic Me5 lesions were produced under avertin anesthesia ( $0.36 \text{ g kg}^{-1}$ ) with 0.2-mm-diameter stainless steel electrodes at 6 wk of age. Using a stereotaxic apparatus, the electrode was positioned 5.3 mm posterior to bregma, 0.9 mm lateral to the midsagittal suture, and 3.2 mm below the surface of the skull. Anodal electrolytic lesions were produced by passing a 1.3-mA current for 1 s, three times. Out of 16 mice that received lesions, 7 had successful bilateral Me5 lesions, 7 had unilateral Me5 lesions, and 2 had lesions in peri-Me5 regions. All successful Me5 lesions were restricted to the caudal level of the Me5. Sham-operated mice (7 mice) underwent an identical operation, except no current was passed. Histologic analysis was performed by light-microscopic examination. After fixation with 10% neutral buffered paraformaldehyde solution and embedding in paraffin, serial brain sections (4  $\mu\text{m}$  thick) were

stained with hematoxylin-eosin to reveal the extent of damage to the Me5. Only the data from mice with successful Me5 lesions were used.

### **Feeding and exploratory behavior under standard living conditions**

The training task was conducted by placing mice in the FSCA for 2 wk (from 4 - 6 wk of age). A food chamber containing pellets and an empty chamber were connected to the left and right cylinders, respectively. Bilateral electrolytic Me5 lesions were produced at 6 wk of age. The mice were returned to normal plastic cages and maintained for 2 wk. After a 2-wk recovery period, mice were transferred back to the FSCA and maintained for 2 wk. Entries into the food chamber were designated as feeding. Entries into the empty chamber were designated as exploratory behavior, although whether mice explored their territory with a specific aim was not determined. Feeding and exploratory behavior were recorded at 10 wk of age.

### **Exploratory activities in an unfamiliar environment**

General exploratory activities, i.e., total locomotor activity, frequency and duration of rearing and head-dipping, and latency to the first head-dipping, were recorded using an automated hole-board apparatus (model ST-1, Muromachi Kikai Co., Ltd., Japan), which consisted of a gray wooden box (50 x 50 x 50 cm) with four equidistant holes (3 cm diameter) in the floor. An infrared beam sensor was installed in the wall of each hole to detect the frequency and duration of rearing and head-dipping behaviors and the latency to the first head-dipping. Other behavioral parameters such as location, distance, and speed of movement of mice in the hole-board were recorded by an overhead color CCD camera; the heads of the mice were painted yellow and the color CCD camera

tracked their centre of gravity. Data from the infrared beam sensor and the CCD camera were collected through a custom-designed interface (CAT-10, Muromachi Kikai Co., Ltd.) as a reflection signal. Head-dipping behaviors were double-checked via the infrared sensor and the overhead color CCD camera. Thus, only when both the head intercepted the infrared beam and the head was detected at the hole by the CCD camera was head-dipping behavior counted. All of the data were analyzed and stored in a personal computer using analytical software (Comp ACT HBS, Muromachi Kikai Co., Ltd. ). Mice were placed in the center of the hole-board and allowed to freely explore the apparatus for 5 min.

### **Statistical methods**

Statistical significance was determined using Student's unpaired *t* test. A P value of less than 0.05 was considered statistically significant.

### **Animal care and ethical standards**

All procedures for the care and use of experimental animals were approved by the Animal Research Committee in Obihiro University of Agriculture and Veterinary Medicine and were conducted under the Guidelines for Animal Experiments in Obihiro University of Agriculture and Veterinary Medicine and the Guiding Principles in the Use of Animals in Toxicology that were adopted by the Society of Toxicology in 1989. The animals were humanely killed by an overdose of anesthetic ether at the end of the experiment.

## **Results**

### **Profiles of feeding and exploratory behavior in Me5-lesioned and sham-operated mice analyzed in an FSCA under standard living conditions**

To investigate how the Me5 is involved in the control of feeding and exploratory behavior, we analyzed those behaviors in Me5-lesioned and sham-operated mice in an FSCA under standard living conditions. Bilateral Me5-lesioned and sham-operated mice had different feeding and exploratory behavior. Sham-operated mice displayed high-frequency exploratory behavior and repeatedly entered the empty chamber (Fig. 2A). In contrast, bilateral Me5-lesioned mice seldom re-entered the empty chamber, and some never entered it at all (Fig. 2B); this was termed low-frequency exploratory behavior. On the other hand, bilaterally Me5-lesioned mice spent more time in the food chamber during each trial, but the number of entries into the food-containing chamber was lower compared to sham-operated mice (Fig. 2A & B). The number of entries into the empty chamber (exploratory behavior) in both bilaterally and unilaterally Me5-lesioned mice was significantly lower compared to sham-operated mice (Fig. 3A). Thus, Me5 lesions markedly inhibited exploratory behavior in the home cage. On the other hand, the number of entries into the food-containing chamber (feeding behavior) in bilaterally Me5-lesioned mice was significantly decreased by 40% compared to sham-operated mice (Fig. 3B). The total time spent in the food chamber per 24 h, however, was not significantly different between the Me5-lesioned and sham-operated mice (Fig. 3C). There was no significant difference in the mean body weight between the Me5-lesioned and sham-operated mice (Fig. 1C).



## **Various exploratory activities in Me5-lesioned and sham-operated mice analyzed by an automated hole-board apparatus in an unfamiliar environment**

Me5 lesions markedly inhibited exploratory behavior in the FSCA (Fig. 2B). This low-frequency exploratory behavior in Me5-lesioned mice might be due to increased anxiety induced by Me5 lesions. We, therefore, analyzed various exploratory activities in Me5-lesioned and sham-operated mice in an unfamiliar environment using an automated hole-board apparatus and compared the activity between them. The hole-board system is a simple method for measuring the response of an animal to an unfamiliar environment [1,13] and is a useful tool for objectively estimating the level of anxiety in mice [15,16,17]. The effect of Me5 lesions on various exploratory activities, i.e., total locomotor activity, frequency and duration of rearing and head-dipping, and latency to the first head-dipping, is shown in Fig. 4. These exploratory activities in Me5-lesioned mice, however, were not significantly different from those in sham-operated mice. Thus, Me5 lesions influence neither spontaneous activity nor exploratory activity in mice in an unfamiliar environment.

## **Discussion**

In the present study, we demonstrated that Me5 lesions change feeding behaviour profiles and inhibit exploratory behavior without affecting the emotional state of mice. The Me5 receives input from oral proprioceptors [7] and projects its fibers into the TMN of the posterior hypothalamus [4]. HA neurons in the TMN project to the VMH and also to the Me5 [8,9,14]. The depletion of neuronal HA from the Me5 or the VMH affects eating parameters and meal duration [6]. Thus, the oral proprioceptive signals induced by mastication modulate hypothalamic HA

neurons through the ascending pathway from the Me5, and the hypothalamic feeding center controls masticatory function via the Me5.

Recent studies demonstrated that the Me5 is involved in mastication-induced modulation of satiation via the satiety center of the VMH [6,14]. The Me5 is thought to transfer proprioceptive signals to the VMH through HA neurons in the TMN [14]. In the FSCA in the present study, bilaterally Me5-lesioned mice spent more time in the food chamber during each trial, but the number of entries into the food-containing chamber was lower, compared to sham-operated mice (Fig. 2). The total time spent in the food chamber per 24 h, however, was not significantly different between the Me5-lesioned and sham-operated mice (Fig.3C). Because meal duration is prolonged when neuronal HA is depleted in the VMH [6], Me5-lesions might affect the activity of HA neurons in the VMH and result in a longer stay in the food chamber during each trial to eat food. Alternatively, Me5- lesions might change the feeding profile itself by affecting the satiety center of the VMH. In either case, these results suggest that the Me5 is involved in the control of feeding behavior, which can be caused by transmitting oral proprioceptive signals to the VMH through the TMN as well as mastication-induced modulation of satiation.

Sham-operated mice displayed high-frequency exploratory behavior and repeatedly entered the empty chamber (Fig. 2A). In contrast, bilaterally Me5-lesioned mice seldom re-entered the empty chamber, and some never entered it at all (Fig. 2B). Thus, Me5 lesions markedly inhibited exploratory behavior in the FSCA. The low-frequency exploratory behavior in Me5-lesioned mice might be due to increased anxiety induced by Me5 lesions. We, therefore, analyzed exploratory activity in an unfamiliar environment using an automated hole-board apparatus, which is a useful tool for objectively estimating the level of anxiety in mice [15,16,17]. There were no significant

differences in any exploratory activities, i.e., total locomotor activity, frequency and duration of rearing and head-dipping, and latency to the first head-dipping, however, between Me5-lesioned and sham-operated mice. Thus, Me5 lesions did not affect the emotional state of mice. These results strongly suggest that the Me5 is involved in the control of feeding and exploratory behavior without modulation of the emotional state of mice.

The development and excitability of the central nervous system are modulated by signals derived from dietary properties via sensory afferent neurons [6,10,11,14]. Moreover, a soft-diet after the weaning period reduces synaptic formation in the cerebral cortex and impairs spatial learning ability in adulthood [18]. There is a possible link between reduced mastication and hippocampal neuron loss in senile impairment of spatial memory [12,18]. Thus, it seems that sensory signals from oral proprioceptors transmit to higher brain regions via the Me5 and affect brain function and development. Moreover, the Me5 might modulate signal transmission of bi-directional signal pathways (i.e., “from hypothalamic regions to motor trigeminal nucleus” and “from oral proprioceptors to hypothalamic regions”) necessary for control of feeding and exploratory behavior other than satiation.

### ***References***

- [1] J.R. Boisser, P. Simon, Dissociation de deux composantes dans le compartiment d'investigation de la souris, *Arch. Int. Pharmacodyn.* 147 (1964) 372-387.
- [2] K.B. Corbin, F. Harrison, Function of mesencephalic root of fifth cranial nerve, *J. Neurophysiol.* 3 (1940) 423-435.

- [3] H. Ericson, A. Blomqvist, C. Kohler, Brainstem afferents to the tuberomammillary nucleus in the rat brain with special reference to monoaminergic innervation, *J. Comp. Neurol.* 281 (1989) 169-192.
- [4] H. Ericson, A. Blomqvist, C. Kohler, Origin of neuronal inputs to the region of the tuberomammillary nucleus of the rat brain, *J. Comp. Neurol.* 311 (1991) 45-64.
- [5] T. Fujise, H. Yoshimatsu, M. Kurokawa, K. Fukagawa, M. Nakata, T. Sakata, Food consistency modulates eating volume and speed through brain histamine in rat, *Brain Res. Bull.* 32 (1993) 555-559.
- [6] T. Fujise, H. Yoshimatsu, M. Kurokawa, A. Oohara, M. Kang, M. Nakata, T. Sakata, Satiating and masticatory function modulated by brain histamine in rats, *Proc. Soc. Exp. Biol. Med.* 217 (1998) 228-234.
- [7] F. Harrison, K.B. Corbin, The central pathway for the jaw-jerk, *Am. J. Physiol.* 135 (1942) 439-445.
- [8] N. Inagaki, A. Yamatodani, K. Shinoda, Y. Shiotani, M. Tohyama, T. Watanabe, H. Wada, The histaminergic innervation of the mesencephalic nucleus of the trigeminal nerve in rat brain: a light and electron microscopical study, *Brain Res.* 418 (1987) 388-391.
- [9] N. Inagaki, A. Yamatodani, M. Ando-Yamamoto, M. Tohyama, T. Watanabe, H. Wada, Organization of histaminergic fibers in the rat brain, *J. Comp. Neurol.* 273 (1988) 283-300.
- [10] Z.J. Liu, K. Ikeda, S. Harada, Y. Kasahara, G. Ito, Functional properties of jaw and tongue muscles in rats fed a liquid diet after being weaned, *J. Dent. Res.* 77 (1998) 366-376.

- [11] Y. Masumoto, T. Morinushi, H. Kawasaki, M. Takigawa, Spectral analysis of changes in electroencephalographic activity after the chewing of gum, *Psychiatry Clin. Neurosci.* 52 (1998) 587-592.
- [12] M. Onozuka, K. Watanabe, S.M. Mirbod, S. Ozono, K. Nishiyama, N. Karasawa, I. Nagatsu, Reduced mastication stimulates impairment of spatial memory and degeneration of hippocampal neurons in aged SAMP8 mice, *Brain Res.* 826 (1999) 148-153.
- [13] E.L. Rodriguez Echandia, S.T. Broitman, M.R. Foscolo, Effect of the chronic ingestion of chlorimipramine and desipramine on the hole board response to acute stresses in male rats, *Pharmacol. Biochem. Behav.* 26 (1987) 207-210.
- [14] T. Sakata, H. Yoshimatsu, T. Masaki, K. Tsuda, Anti-obesity actions of mastication driven by histamine neurons in rats, *Exp. Biol. Med.* 228 (2003) 1106-1110.
- [15] H. Takeda, M. Tsuji, T. Matsumiya, Changes in head-dipping behavior in the hole-board test reflect the anxiogenic and/or anxiolytic state in mice, *Eur. J. Pharmacol.* 350 (1998) 21-29.
- [16] M. Tsuji, H. Takeda, T. Matsumiya, Different effects of 5-HT<sub>1A</sub> receptor agonists and benzodiazepine anxiolytics on the emotional state of native and stressed mice: a study using the hole-board test, *Psychopharmacology* 152 (2000) 157-166.
- [17] M. Tsuji, H. Takeda, T. Matsumiya, Protective effects of 5-HT<sub>1A</sub> receptor agonists against emotional changes produced by stress stimuli are related to their neuroendocrine effects, *Br. J. Pharmacol.* 134 (2001) 585-595.
- [18] T. Yamamoto, A. Hirayama, Effects of soft-diet feeding on synaptic density in the hippocampus and parietal cortex of senescence-accelerated mice, *Brain Res.* 902 (2001) 255-263.

### ***Figure legends***

Figure 1. Food-search-compulsion-apparatus (FSCA) and changes in body weight after bilateral Me5 lesions. (A) Illustration of the food-search-compulsion-apparatus (FSCA). The FSCA is an acrylic cage equipped with two separate vertical stainless steel wire cylinders, the top of which has a chamber containing either food (food pellets) or nothing. The number of entries into the empty and the food containing chambers was termed exploratory and feeding behavior, respectively. (B) Histologic analysis of hematoxylin & eosin-stained brain sections in Me5-lesioned (a, b) and sham-operated mice (c, d). Scale bar, 1 mm (a, c) and 100  $\mu\text{m}$  (b, d). Asterisks show the sites of the electrolytic lesions of Me5 and the area of lesion is bordered by broken line. (C) Changes in body weight of bilaterally Me5-lesioned mice (n=7) and sham-operated mice (n=7) after surgery at 6 wk of age. Except for the analysis of feeding and exploratory behaviors in the FSCA, the mice were maintained in normal plastic cages and fed food and water *ad libitum*. Feeding and exploratory behaviors were recorded in an FSCA at 10 wk of age, and general exploratory activities using a hole-board apparatus were recorded at 11 wk. The mean body weight of Me5-lesioned mice was not significantly different from that of sham-operated mice. Vertical bars represent SD.

Figure 2. Feeding and exploratory profiles in bilaterally Me5-lesioned and sham-operated mice housed in an FSCA. (A and B) Feeding and exploratory profiles in sham-operated mice (A) and bilaterally Me5-lesioned mice (B) at 10 wk of age. Sham 1-5 and Lesion 1-6 represent the profiles of different mice in each group.

Figure 3. Comparison of feeding and exploratory behavior between sham-operated and Me5-lesioned mice. (A) Exploratory behavior in unilaterally (n=7) and bilaterally Me5-lesioned mice (n=7) was significantly lower than that in sham-operated mice (n=7). (B and C) Comparison of the number of entries into the food chamber (B) and time spent in the food chamber (C) between sham-operated mice and Me5-lesioned mice. The number of entries into the food chamber, but not time spent in the chamber in bilaterally Me5-lesioned mice (n=7), was significantly lower than that in sham-operated mice (n=7). Vertical bars represent SD. Asterisk indicates  $p < 0.05$ . Double asterisk indicates  $p < 0.01$ . Statistical significance was determined using the unpaired Student's *t* test.

Figure 4. Effect of bilateral Me5 lesions on general exploratory activities in the automated hole-board test. Exploratory activities on the hole-board, i.e., total locomotor activity, frequency and duration of rearing and head-dipping, and latency to the first head-dipping, were measured for 5 min. Vertical bars represent SD.

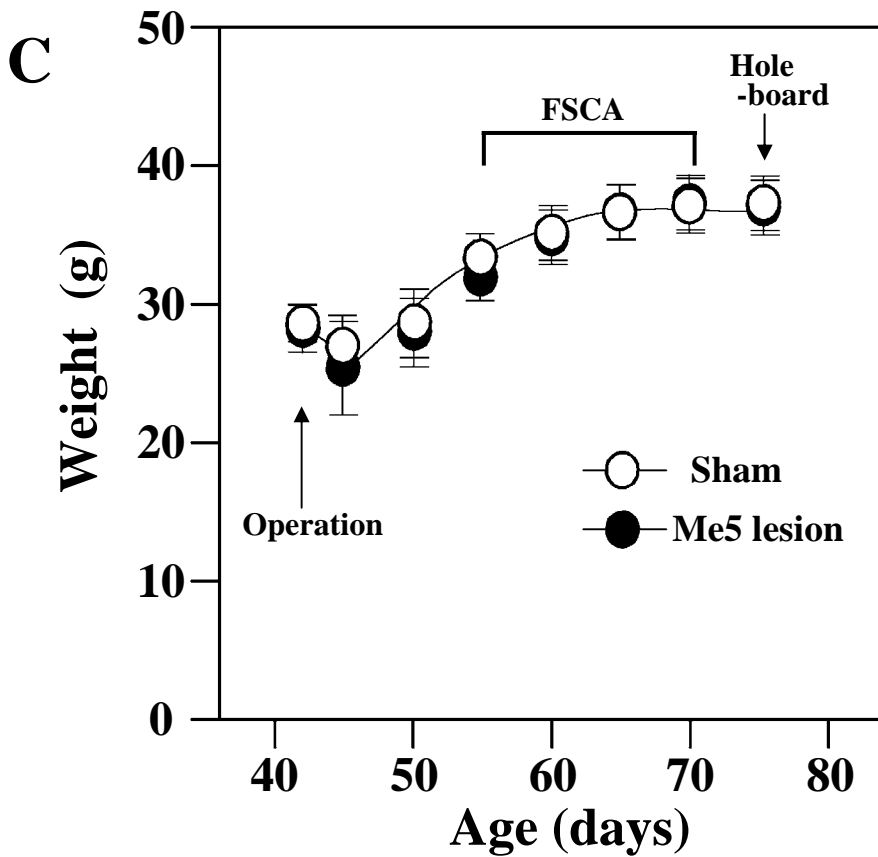
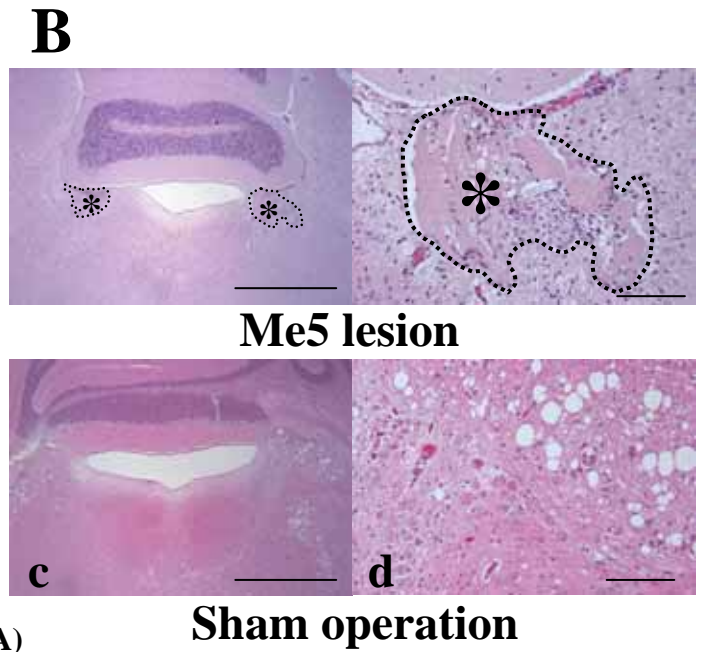
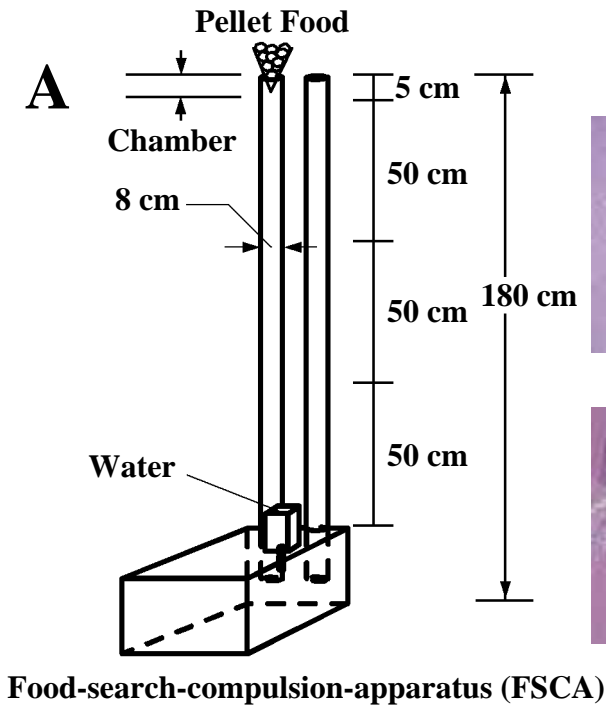



## A Feeding and exploring profiles in sham-operated mice

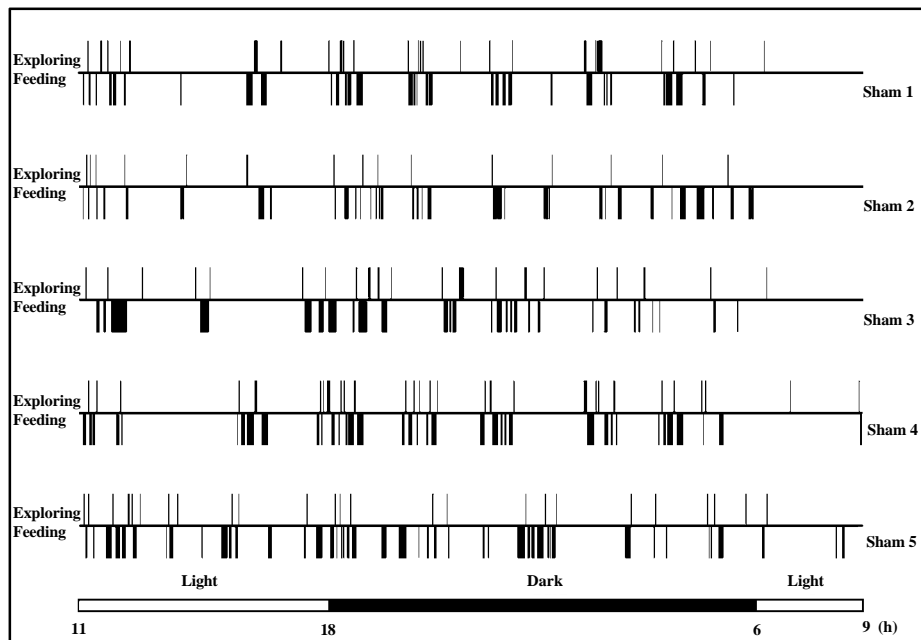

## B Feeding and exploring profiles in mice with Me5 lesions

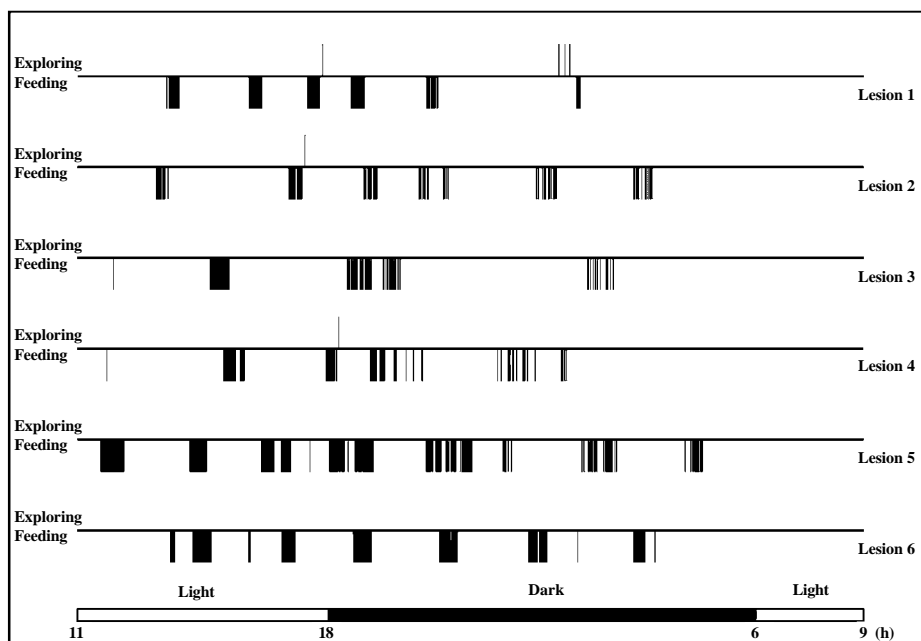

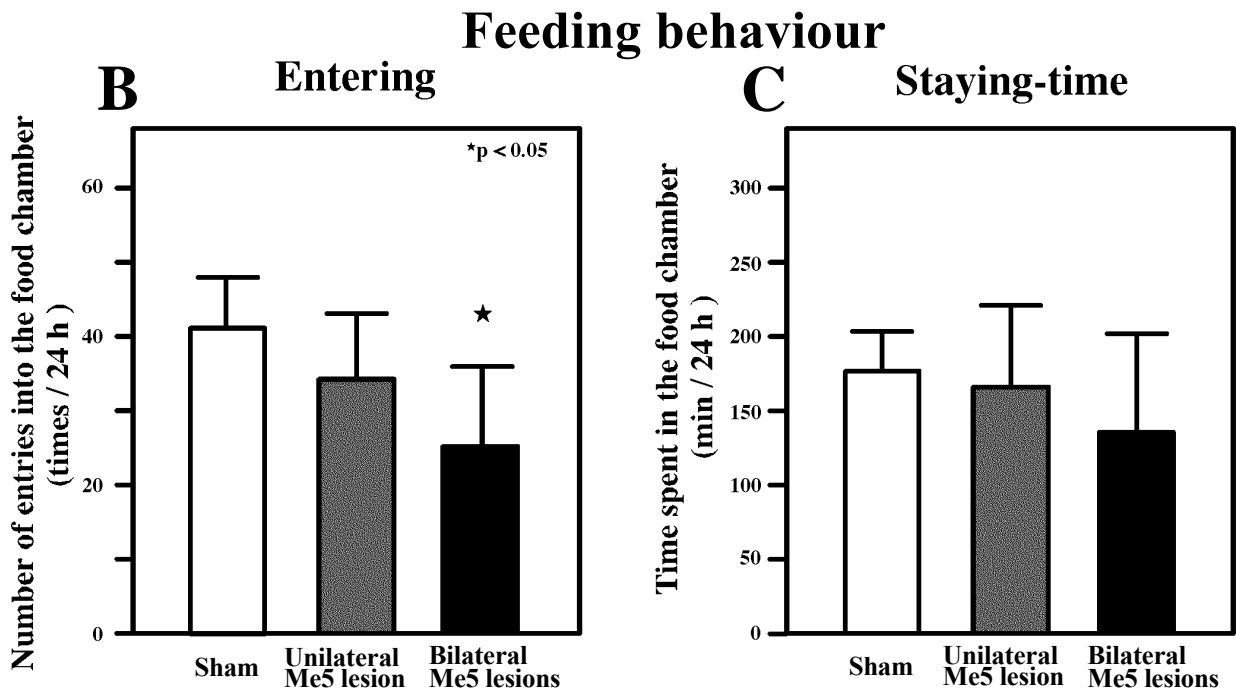
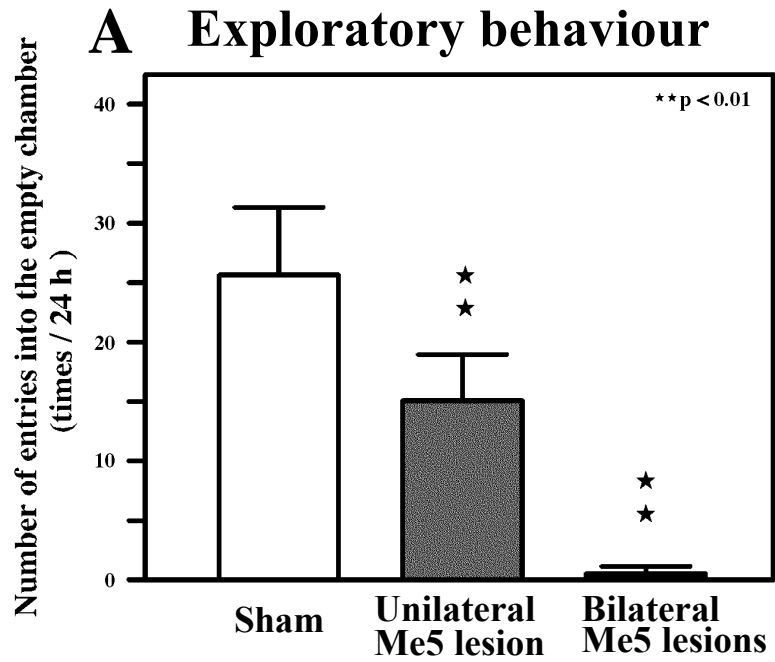

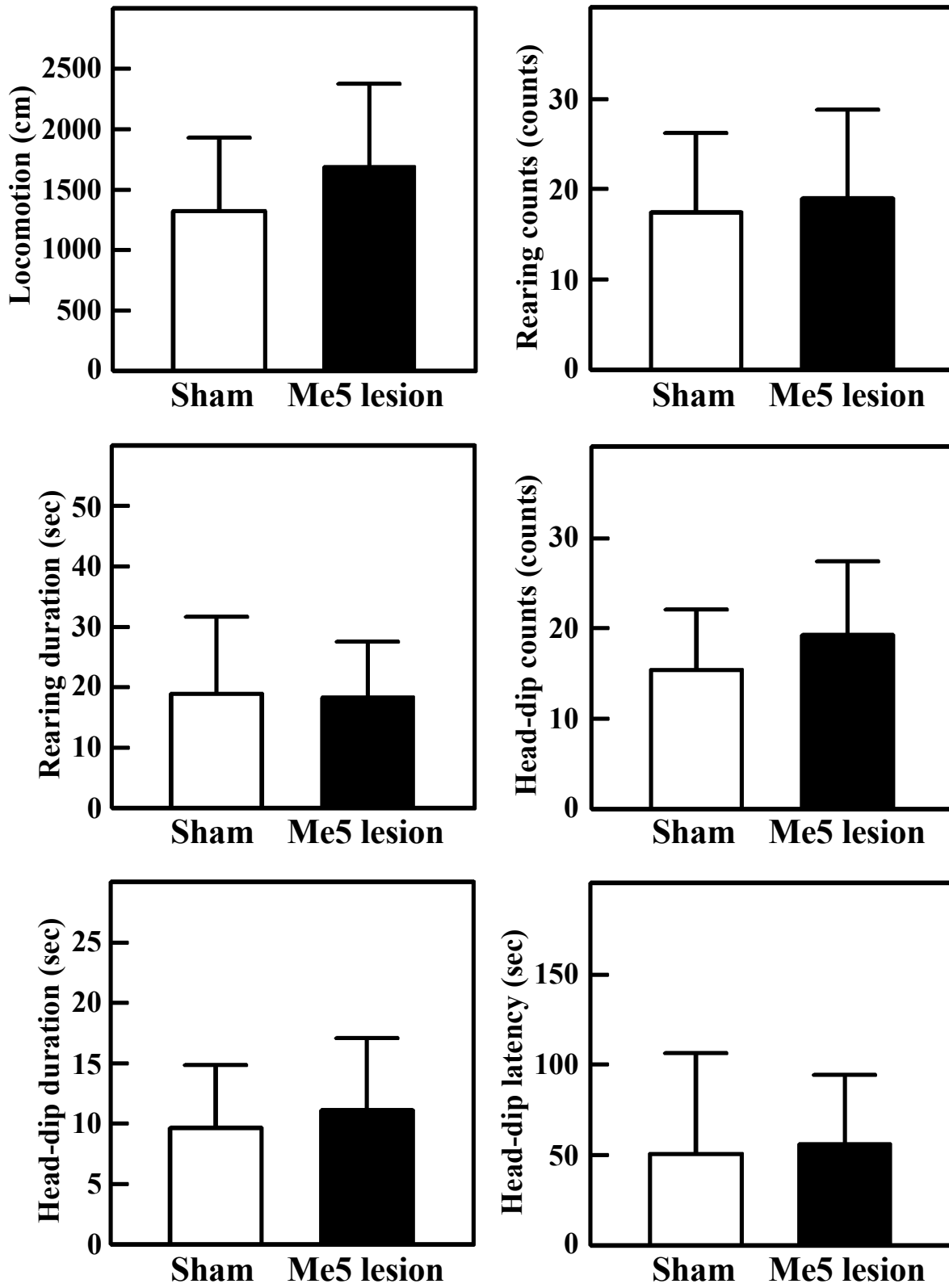

Ishii et al. Fig.4